

ENERGIZER 362/361

ZEROMERCURY®

SILVER OXIDE



Industry Standard Dimensions

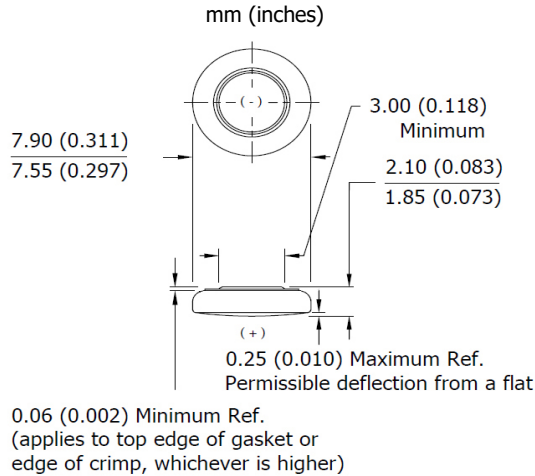

DESIGNED FOR USE ON CONTINUOUS LOW DRAIN
HIGH PULSE ON DEMAND

Specifications

Chemical System:	Silver Oxide (Zn/Ag ₂ O)
Designation:	ANSI-1158SO, IEC-SR58
Nominal Voltage:	1.55 Volts
Typical Capacity:	27 mAh* (to 1.2 volts)
Capacity Test:	47K ohm continuous drain at 21°C
Typical Weight:	0.4 grams (0.06 oz.)
Typical Volume:	0.10 cubic centimeters (0.023 cubic inch)
Impedance (40 Hz):	15 to 25 ohms

* Varies according to the applied load, temperature, and cutoff voltage.

Cross Section

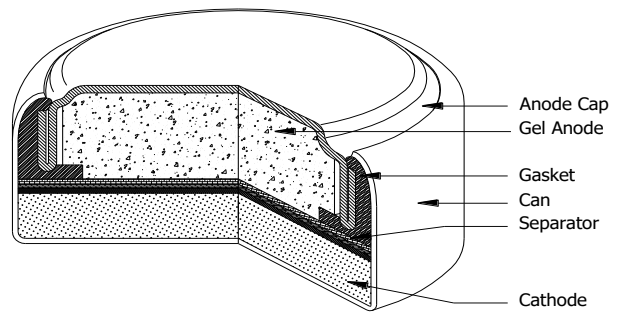

Typical Discharge Characteristics

Typical Performance at 21°C (70°F)

Schedule: Continuous
Typical Drain @1.55V:
0.033 milliamperes
Load: 47K ohm

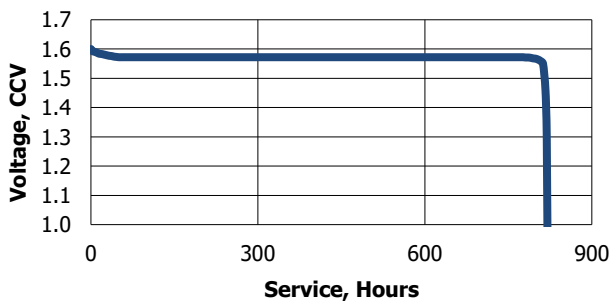

Schedule	Typical Drains at 1.55V (milliamperes)	Load (ohm)	Cutoff (hours)
Continuous	0.033	47K	819

Temperature Characteristics

Typical Performance at Low Discharge rates

Service Effects

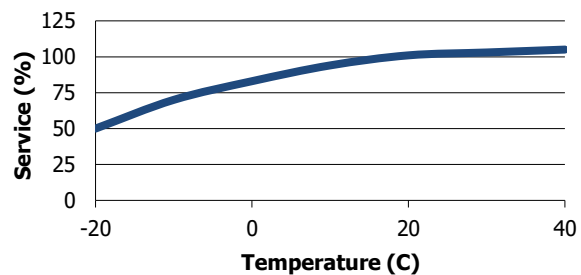

Storage Effects

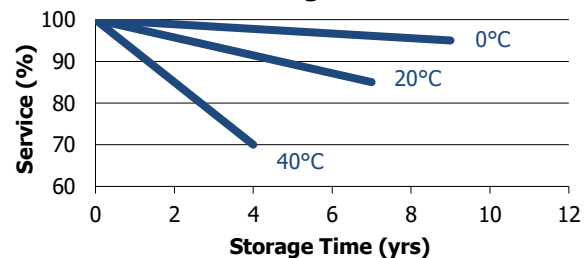

Important Notice

This datasheet contains typical information specific to products manufactured at the time of its publication.
Contents herein do not constitute a warranty and are for reference only.