

## 2 MANGANESE DIOXIDE LITHIUM BATTERIES (CR SERIES)

### CR-1632

#### DIMENSIONS (MM)

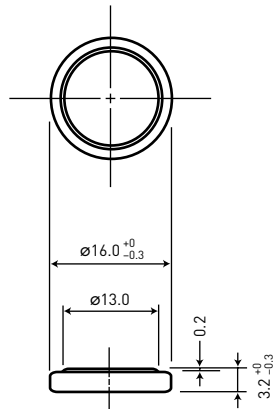

Model number	CR-1632
Nominal voltage (V)	3
Nominal capacity (mAh)	140
Diameter (mm)	16.0
Total height (mm)	3.2
Discharging temperature range (°C)	-30 to +60
Weight (g)	1.8

#### DISCHARGE TEMPERATURE CHARACTERISTICS

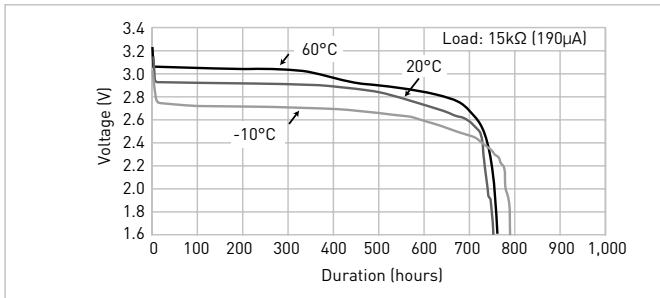

#### OPERATING VOLTAGE VS. DISCHARGE CURRENT\*1

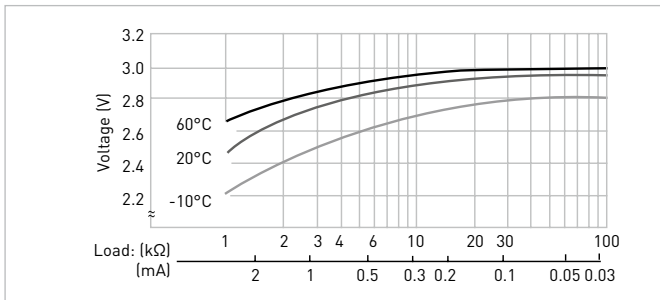

#### CAPACITY VS. LOAD RESISTANCE

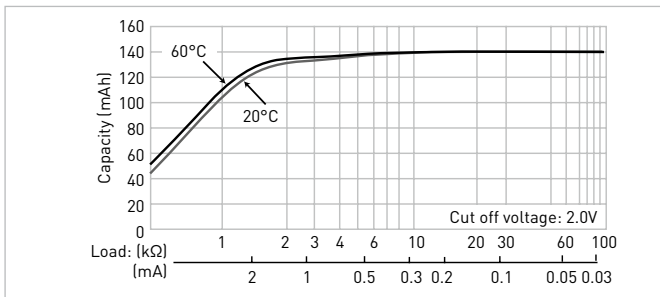

### CR-2012

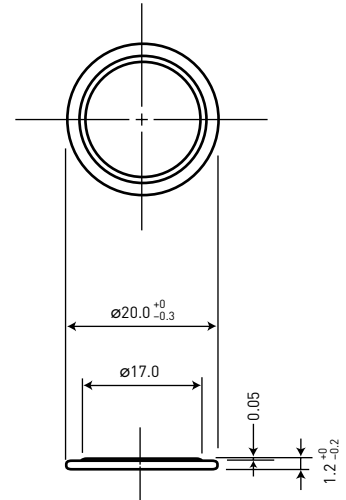

Model number	CR-2012
Nominal voltage (V)	3
Nominal capacity (mAh)	55
Diameter (mm)	20.0
Total height (mm)	1.2
Discharging temperature range (°C)	-30 to +60
Weight (g)	1.4

#### DISCHARGE TEMPERATURE CHARACTERISTICS

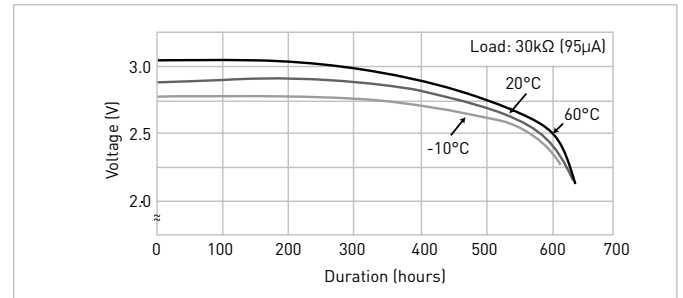

#### OPERATING VOLTAGE VS. DISCHARGE CURRENT\*1

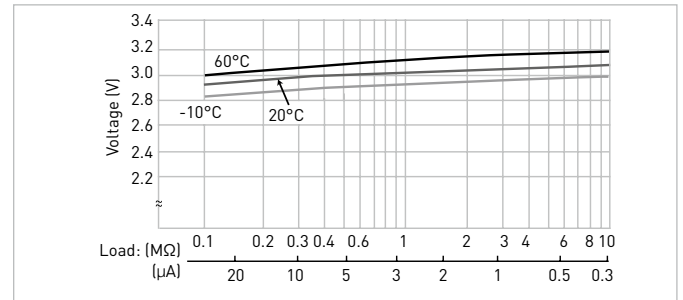

#### CAPACITY VS. LOAD RESISTANCE

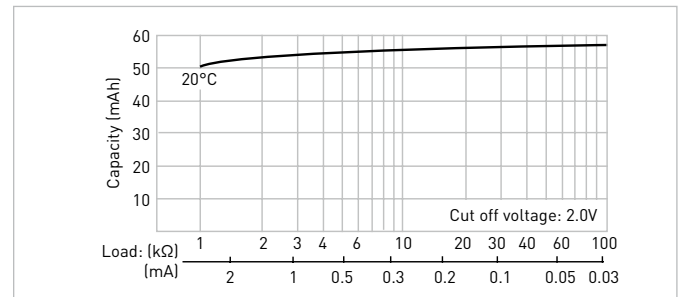

The data in this document are for descriptive purposes only and are not intended to make or imply any guarantee or warranty.

\*1 Voltage at 50% discharge depth.