

CR1612

■ Dimensions(mm)

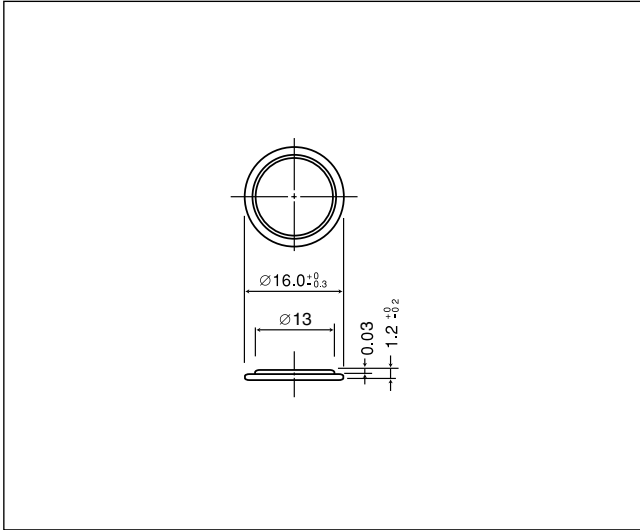

■ Specification

Nominal voltage(V)	3
Nominal capacity(mAh)	40
Continuous drain(mA)	0.1
Operating temperature(°C)	-30 to +60

■ Discharge temperature characteristics

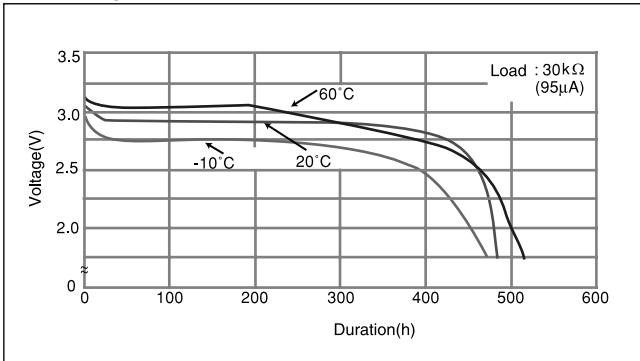

■ Operating voltage vs. load resistance(voltage at 50% discharge depth)

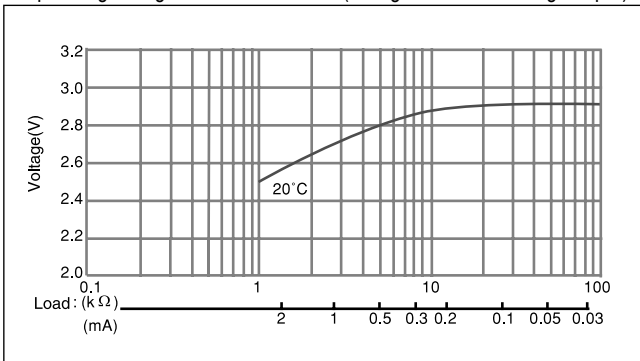

■ Capacity vs. load resistance

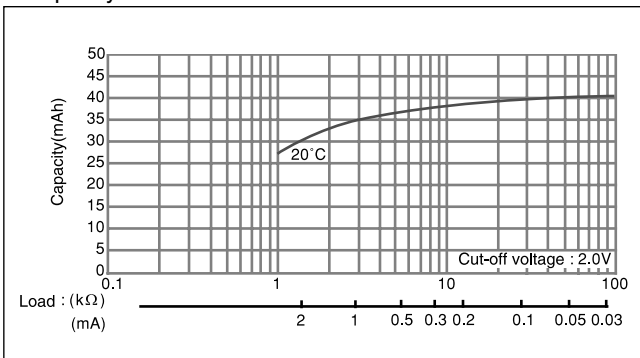

CR1616

■ Dimensions(mm)

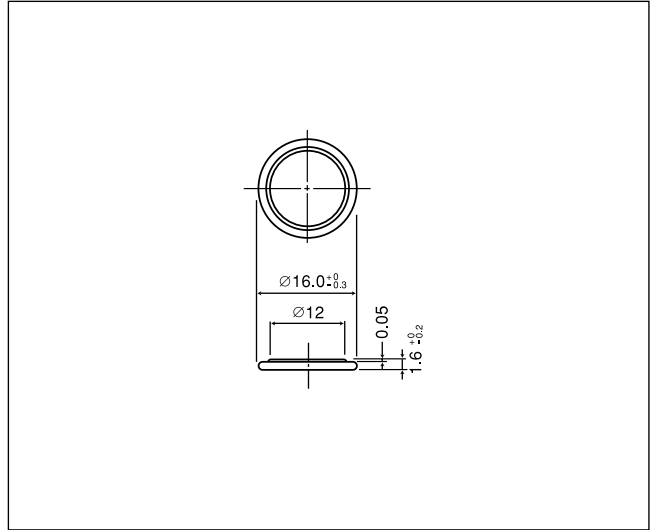

■ Specification

Nominal voltage(V)	3
Nominal capacity(mAh)	55
Continuous drain(mA)	0.1
Operating temperature(°C)	-30 to +60

■ Discharge temperature characteristics

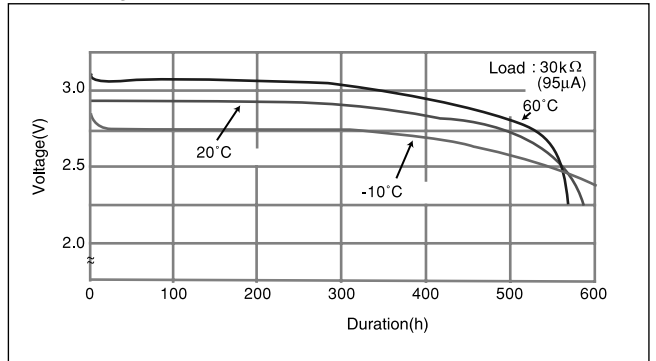

■ Operating voltage vs. load resistance(voltage at 50% discharge depth)

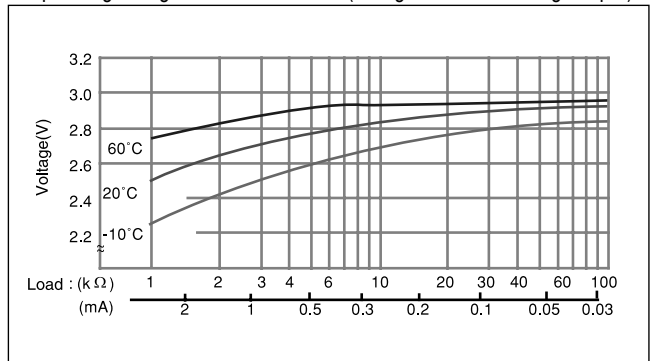

■ Capacity vs. load resistance

